

Design of Energy Harvesters on Motorcycle Exhaust using Thermoelectric Generator for Power Supply Electronic Device

by Erna Wati

Submission date: 14-Oct-2020 12:42PM (UTC+0700)

Submission ID: 1414740843

File name: EH_Motorcycle.pdf (4.88M)

Word count: 4583

Character count: 23586

Design of Energy Harvesters on Motorcycle Exhaust using Thermoelectric Generator for Power Supply Electronic Device

Fitria Hidayanti*[‡], Erna Kusuma Wati*, M. Fathur Miftahudin*

*Engineering Physics Department, Faculty of Engineering and Science, Universitas Nasional, Jakarta, Indonesia 12520

(fitriahidayanti@gmail.com, ernakusuma.w@gmail.com, fathurmiftahudin@gmail.com)

‡

Corresponding Author; Fitria Hidayanti, 12520, Tel: +62 8211 1111 7713, Fax: +62 2178 91753, fitriahidayanti@gmail.com

Received: xx.xx.xxxx Accepted:xx.xx.xxxx

Abstract- One of the excess energies in the environment is motorcycle exhaust gas. Motorcycles with internal combustion engines produce energy waste where around 40% of the fuel energy is wasted in the form of heat energy through the exhaust to the environment. Various research studies to utilize the heat of motorcycle exhaust have been conducted, but the electric voltage generated is still below 5V. Therefore, it is not enough to be used as a power source for electronic devices using Universal Serial Bus (USB). This study aims to design an energy harvesting system using two modules of TEG TE-MOD-10W4V-40 that are organized in series and mounted on a motorcycle exhaust. The design of the device includes the construction of the heat exchanger, the boost converter circuit, and the charger box. The test results show that the maximum electrical voltage is successfully generated in a no-load condition of 4.2V with a temperature difference of 57°C. The design of the device is able to charge electronic devices such as speakers, smartphones, and tablets with an output voltage of 5.2V. The time needed since the motorcycle engine started to reach a constant voltage was 3 minutes.

Keywords Energy harvesters, thermoelectric generator, boost converter, Seebeck voltage.

1. Introduction

This transportation sector is a sector that produces substantial heat waste. Data of the Central Statistics Agency in 2017 show that the number of motorcycle ownership in Indonesia has reached more than 113 million units [1]. However, behind the big number of motorcycles, there is a potential for harvesting energy produced by internal combustion engines, where around 40% of fuel energy is wasted in the form of heat energy to the environment [2].

Diverse technologies for utilizing waste heat in motorcycles have been applied, such as a thermoelectric generator (TEG). This technology works based on Seebeck

effect. By maintaining temperature differences on both sides, TEG will convert directly from heat energy into electrical energy. The higher temperature difference among two sides, the higher difference in the potential for electricity produced.

TEG has some advantages such as environmentally safe, simple, concise, lightweight and noiseless [3]. The disadvantage of TEG is its efficiency, which is still relatively low. However, if the energy source used is heat waste such as in motorcycle exhaust, then efficiency is not a problem anymore.

Based on the several studies that have been conducted previously [4-7], the value of the electric voltage generated is still below 5V. Therefore, it is not enough to be used as a

resource for electronic devices using Universal Serial Bus (USB). Some factors that cause the small voltage generated are the TEG module used in the experiments is far from optimized. The module that was used is the most advanced module commercially available. The heat sink was not optimized for this application, and there was no hot-side heat sink present [8]. Another cause is cooling by aluminum fins is not optimal, so that it affects the temperature difference between the hot side and the cold side of the module. As a result, the voltage generated still low [9]. In addition, the boost converter technology is not yet implemented, resulted in the inability of the device to provide the voltage level required by a USB-based electronic device, which is equal to 5V.

Harvesting energy is defined as an effort to collect energy that has relatively small value and then stored in a storage medium to accumulate into higher energy and is used as a power provider [10, 11]. Energy sources that can be utilized in the form of ambient sources, including temperature gradients, light, electromagnetic radiation, chemical energy and motion [12]. These various forms of energy are converted into more useful forms of energy, which is electrical energy. Energy harvesting systems, in general, are shown in Fig. 1.

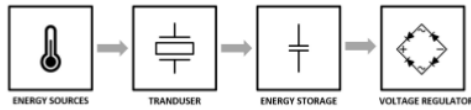

Fig. 1. Block diagram of energy harvesters [13].

The internal combustion engine (ICE) is the result of an engineered mechanism of the energy conversion process which is widely used nowadays, particularly in the transportation, agriculture, and industrial sectors. Sankey diagram explains the balance of heat in, heat out, and heat that is used when combustion occurs at ICE. In vehicles that use gasoline-fueled ICE, approximately 40% of the energy generated from the fuel is moved by exhaust gas in the exhaust, 30% is transferred to coolant, 5% is wasted as harvester losses and only 25% is converted into effective work. Fig. 2 shows the energy distribution of a gasoline-fueled ICE.

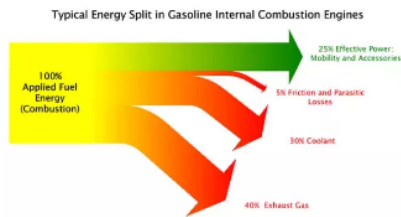

Fig. 2. Diagram Sankey of ICE [14].

The thermoelectric effect was revealed from nearly 200 years ago by the Estonian-German physicist Thomas Johann Seebeck in 1821. He observed that when two different conductors are connected by two sides with different temperatures, an electromotive force (EMF) will appear on

the end of the terminal, known as the Seebeck voltage. The voltage is expressed in Eq. (1) :

$$U = \alpha \cdot \Delta T = \alpha \cdot (T_h - T_c) \quad (1)$$

Notes:

- U = Seebeck Voltage (V)
- α = Seebeck Coefficient (V/°C)
- ΔT = Temperature Difference (°C)
- T_h = Hot Side Temperature (°C)
- T_c = Cool Side Temperature (°C)

The TEG module is arranged one or more thermoelectric pairs which consists of p-type and n-type semiconductor material pairs forming a thermocouple. The material pair is in the form of electrically connected and thermally parallel legs. The pair of materials that make up this connection is flanked by two ceramic plates.

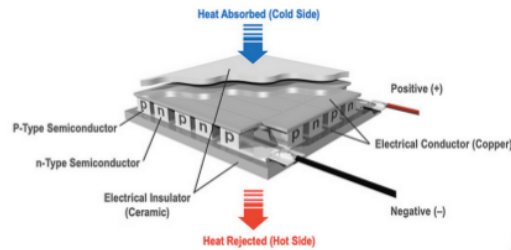

Fig. 3. TEG module [15].

The boost converter is a series of power electronics that produces an output voltage higher than the input one. It is classified as a DC-DC converter class of Switch-Mode Power Supply (SMPS) consisting of power semiconductor components (diodes and transistors), inductors as energy storage elements and capacitors as filters to reduce voltage ripples at the input and output of the converter. In this study, TPS61030 as a family of integrated circuit (IC) of boost converter categories released by Texas Instruments is used.

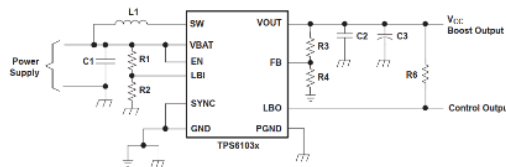

Fig. 4. Boost converter circuit of IC TPS61030 [16].

Hence, this study aims to design and implement an energy harvester system on motorcycle exhaust using a TEG module that is capable of producing an electrical voltage of 5.2V.

2. Materials and Method

This study applied the concept of energy harvesting using two TEG modules of TE-MOD-10W4V-40 typed constructed in series and mounted on a motorcycle exhaust. When the engine is started, the exhaust gas will flow through the exhaust pipe. This high-temperature gas heats the exhaust so that heat will be absorbed by the hot side of the module. On the cold side, it is carried out by convection cooling through the heat sink. The temperature difference between the hot side and the cold side generate electrical energy. This electrical energy is stored in the battery to be accumulated higher energy and functions as a power provider. The output from the battery is connected to the boost converter to increase the voltage to the voltage level of 5.2V.

Device design

The design of this energy harvester consists of 2 parts, the design of the harvester and the electronic units. The design of the harvesting unit is in the form of a heat exchanger construction consisting of a heat transfer block and heat sink. Meanwhile, the design of the electronic unit includes the manufacture of a boost converter and its integration with a Li-ion battery, voltmeter display and battery charger. The device block diagram is shown in Fig. 5.

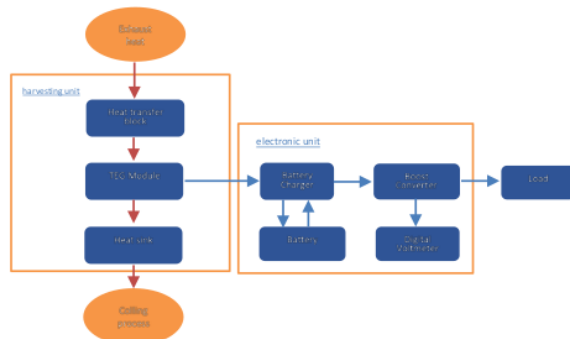

Fig. 5. Block diagram of the device.

The Design of Harvesting Unit

The harvesting unit is designed to absorb heat to the maximum and produce big temperature differences. The material chosen in this construction is aluminium 6061, which has a conductivity of 200 W/m.K. The figure of the parts assembly of the harvester unit construction is shown in Fig. 6.

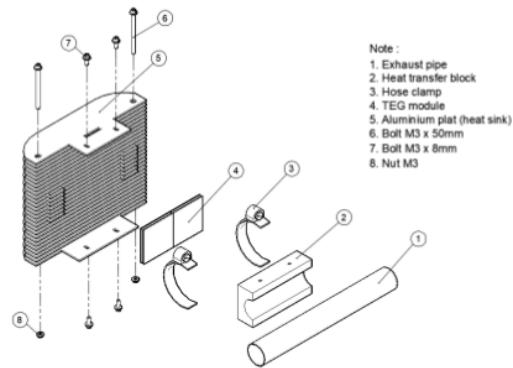

Fig. 6. Construction of harvester unit.

Subsequently, a thermal simulation is performed on the design results of the heat transfer block and heat sink using Solidworks 2018 software. This simulation is conducted to see the temperature distribution of the heat transfer block and heat sink so that the difference in temperature produced can be seen.

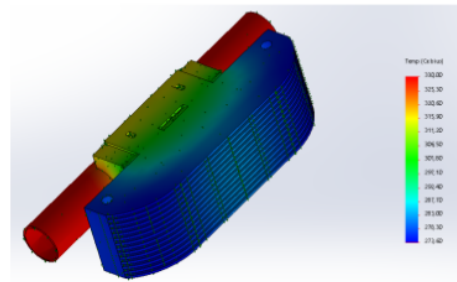

Fig. 7. Temperature distribution simulation of a harvester.

The simulation results in Fig. 7 shows that the temperature obtained on the hot side of the TEG module is around 260 °C, which is the working temperature of the module. Meanwhile, the temperature on the cold side of the module can be maintained by a heat sink around 200 °C. These results indicate that the TEG module can generally operate in line with the working temperature specifications.

Subsequently, the simulated design is used as a reference in the fabrication process. It includes creating heat transfer blocks and heat sinks. The former is made using aluminium blocks of 80 mm x 40 mm x 20 mm. The drilling process using a lathe is performed on an aluminium block to produce a half-cylindrical hole. Fig. 8 shows the heat sink that has been perforated based on the diameter of the exhaust pipe of 23 mm.

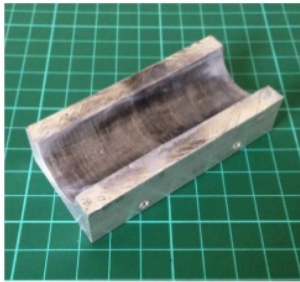

Fig. 8. Heat transfer block.

In the design of the heat sink, aluminium plates with a thickness of 1.6mm are used. On the side that is in contact with the TEG module, there is an area of 2 modules of 80 mm x 40 mm. The design of the heat sink is in the form of 27 fin plates. The fabrication process is performed using a laser cutting machine to cut the plate based on the design. Fig. 9 shows the results of heat sink fabrication.



Fig. 9. Heat sink part assembly.

Fabricated heat sinks and heat transfer blocks are then assembled into one according to the design. At each plate surface, thermal grease is placed to maximize heat transfer between plates. The results of the assembly are shown in Fig. 10.

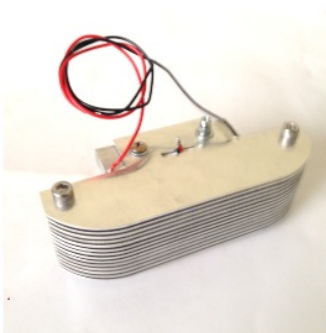

Fig. 10. Harvester unit.

Electronic Unit Design

The electronic unit serves as an energy regulator to meet the load power requirements. The design of the electronic unit includes creating boost converters and charger boxes. This electronic unit consists of several components, including:

- Battery charger served to regulate battery charging.
- Lithium-ion battery with a capacity of 1800 mAh, served as a storage medium for electrical energy produced by the TEG module.
- Boost converter served to raise the battery voltage to the voltage level of 5.2V.
- Voltmeter display served as an indicator of the voltage that was successfully raised by the tool.
- Supporting components are DC switches and jacks.

All components are located and arranged in a charger box for wiring later. The wiring of all components in the charger box is shown in Fig. 11.

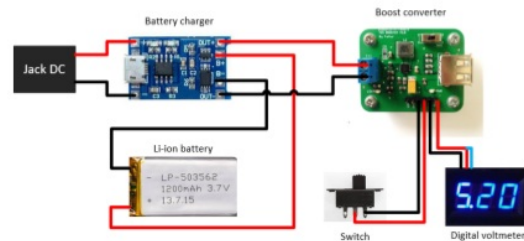

Fig. 11. Electronic unit wiring diagram.

Device Installation

Device installation on a motorcycle is divided into two locations, the exhaust and the front trunk of the motorcycle. The position chosen for the installation of the harvester unit is near the exhaust manifold. The installation position of this unit can be seen in Fig. 12.



Fig. 12. Location of harvester unit installation.

Meanwhile, the electronic unit is placed in the front trunk of the motorcycle to ease the use when charging an electronic device. Fig. 13 shows the results of the charger box design that contains all components of the electronic unit.



Fig. 13. Charger box.

Device testing

Device testing is conducted on each part of harvesting and electronic units. This test is performed to ensure both units can work well before being integrated into an energy harvesting system. Following are the procedures for testing and retrieving data from each unit and component.

Seebeck Voltage Test

This test is performed to determine the Seebeck voltage (open voltage) that has been raised. In this test, the harvester unit is mounted on the muffler and the motorcycle is turned on idle. Seebeck voltage measurements are performed using a multimeter. The procedure of testing is as follows:

1. Installing the harvester unit in the motorcycle exhaust.
2. Installing the thermocouple type thermometer on the hot and cold sides of the TEG modules.
3. Connecting the TEG module output to the multimeter with the DC voltage reading mode.
4. Starting the engine and letting the engine turn to a stationary state.
5. Recording the value of the difference in temperature and the resulting Seebeck voltage starting from the beginning to the value of constant voltage reading.

Boost converter test

The boost converter test is performed to determine the level of input voltage that has been successfully generated. In this test, the power supply is used as an input voltage source. The input voltage varies from the minimum value of the TPS61030 IC specification to its maximum value. Measurement of the output voltage is done using a multimeter. The boost converter testing procedure is as follows:

1. Connecting the DC power supply wiring, boost converter, and a multimeter.
2. Setting the multimeter in the DC voltage reading mode.
3. Lowering the knob to zero, connecting the power supply to the 220V AC voltage source, and setting the voltage to 1.8V.
4. Recording the measured output voltage on the multimeter.
5. Gradually increasing the voltage value by adding 0.4V to 4.2V.

6. Recording the value of the output voltage in each additional voltage value.

Battery charging test

Battery charging test is performed to determine the effect of the voltage on the charging current and the time needed by the electric energy to reach the full state. In this test, the power supply is used as a voltage source. The power supply output voltage varies from a value of 1.8V to 5V. The testing procedure is as follows:

1. Connecting the DC power supply wiring, boost converter, and a lithium-ion battery.
2. Lowering the power supply knob to zero, connecting the power supply to the 220V AC voltage source, and adjusting the voltage to a value of 1.8V and increasing to 5V gradually.
3. Recording the charging current displayed on the power supply at each voltage value variation.
4. Turning off the power supply when charging shows zero.

Load charging testing

After testing and assembling the two parts of the device, the overall device test is conducted to determine the results and performance of the device made. The procedure for harvesting unit testing is as follows:

1. Installing the harvester unit in the motorcycle exhaust.
2. Installing the thermocouple type thermometer on the hot and cold sides of the TEG modules.
3. Connecting the harvester wiring to the electronic unit.
4. Starting the engine and letting the engine turn to a stationary state.
5. Installing the USB digital meter on the USB charger box port. This is performed to ease the reading of the load charging current.
6. Connecting the charger box with a load of USB-based electronic devices consisting of:
 - o Xiaomi Bluetooth speaker @ 600 mAh
 - o Zenfone 2 smartphone @ 4000 mAh
 - o iPad 2 @ 11560 mAh
7. Recording the value of the load current consumption.
8. Repeating steps 1-8 for each type of load.

3. Results and Discussion

This test generates data in the form of temperature differences, Seebeck voltage, electric current to the time function.

Seebeck voltage generation test

This test is performed to see the temperature difference in the harvesting unit to the value of the generated Seebeck voltage and the time needed to reach the maximum voltage. Seebeck voltage measurement is performed shortly after the motorcycle is started until the resulting voltage value is stable at a certain number. Motorcycle engine speed is in idle rotation conditions. The Seebeck stress test data is presented in graphical form in Fig. 14.

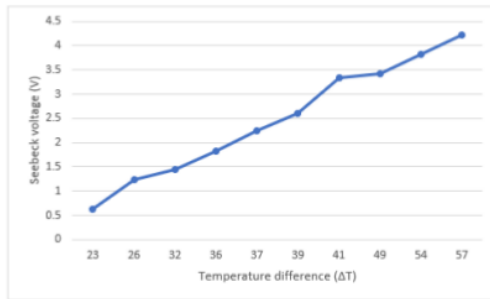

Fig. 14. Seebeck voltage.

The results of the test above show that voltage generated by the tool escalates with growing temperature difference between the hot and cold sides of the TEG modules. Fig. 15 shows the time needed for the device to reach a constant voltage.

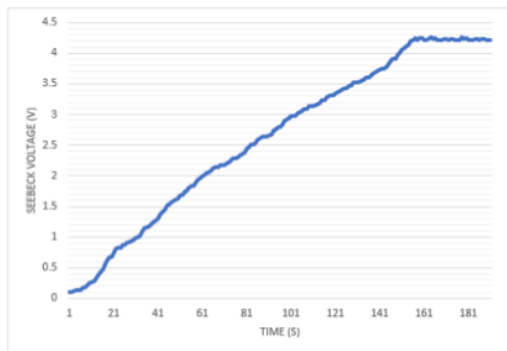

Fig. 15. Seebeck voltage on time.

The test results show that the Seebeck voltage will increase with the length of time the motorcycle is turned on. It is constant after reaching 160 seconds which in this condition is the maximum voltage value produced in the test.

Boost converter test

Boost converter test is performed by giving input voltage variations from 4.2V to 3.0V. The selection of the input voltage is adjusted to the characteristics of the lithium-ion battery, which has a nominal voltage value of 4.2V and a cut-off voltage of 3.0V. By providing these variations, the performance of the output voltage against changes in input

voltage is shown. The test results are shown in Table 1 below.

Table 1. Boost converter test

Voltage input (V)	Voltage output (V)
4.2	5.22
4.0	5.20
3.8	5.21
3.6	5.21
3.4	5.20
3.2	5.20
3.0	5.22

The input voltage value in the test begins from 4.2V, which represents the voltage of the Li-ion battery in full state to a voltage of 3.0V, which is the cut-off voltage value of the battery. The results of the test above (Table 1) shows that the boost converter is designed able to increase the input voltage to the voltage level of 5.2V. The test results, outlined in the graph in Fig. 16 shows that the boost converter can maintain the output voltage value in the range of 5.2V with varying values of the input voltage.

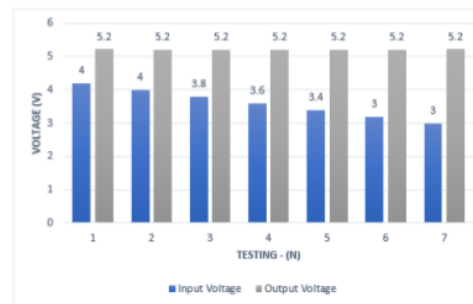

Fig. 16. Graph of boost converter testing.

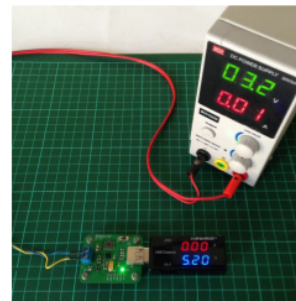

Fig. 17. Boost converter testing.

Battery charging test

Battery charging test is performed to determine the effect of the voltage on the charging current and the length of

time the electric energy is charged to reach the full state. In this test, the power supply is utilised as a voltage source. The power supply output voltage varies based on the specifications of the battery charger modules.

Table 2. Testing Li-Ion battery

Voltage (V)	Current draw (mA)
3.8	380
4	460
4.2	510
4.4	540
4.6	580
4.8	620
5	750

The test result (Table 2) shows that the magnitude of the voltage used to charge the battery affects the charging current. The higher the voltage used, the greater the charging current. Therefore, it speeds up the battery charging time until it is full.

Load charging test

This test is performed to see the ability of the device when providing power to the load. The test is performed by providing a load variation in the form of a USB device that has a different current consumption. Table 3 shows the amount of current applied to each load.

Table 3. Load testing

Type of load	Current draw (mA)
Speaker Xiaomi @ 600 mAh	290
Zenfone 2 @ 4000mAh	450
Ipad 2 @ 11560mAh	550

The results of electrical charging test for Xiaomi speaker are shown in Fig. 18.

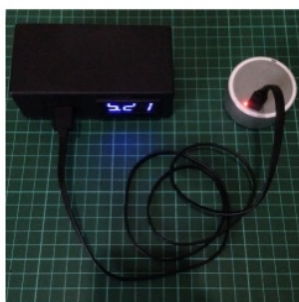

Fig. 18. Charging test of speaker Xiaomi.

Load charging test also conducted on smartphone and tablet devices. The device can charge 4% of Zenfone 2 Smartphone with currents reaching 450 mA (Fig. 19).



Fig. 19. Charging test of Zenfone 2.

Another gadget, the iPad Gen 2 which has a capacity of 11560 mAh battery, can be supplied by devices with a current of 550 mA (Fig. 20). This study has succeeded in designing and implementing an energy harvester system that can harvest heat energy in the exhaust into electrical energy. The electricity produced can be used to charge USB-based electronic devices.

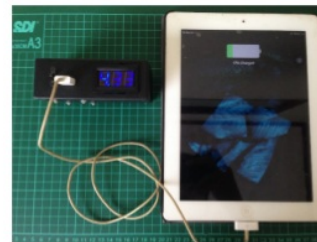

Fig. 20. Charging test of Ipad Gen 2.

Cooling on the heat sink proved to be optimal enough. Therefore, the open voltage successfully generated reached 4.2V. However, the test results show that the temperature difference resulting from this test is not the same as the characteristic curve in the TE-MOD-10W4V-40 module datasheet. It is because of the use of only two thermocouples. Thus, the temperature measurement point does not represent the overall surface temperature of the heat exchanger.

The test results also show that by using a boost converter circuit, the energy harvesting using two TEG modules is capable of producing a voltage of 5.2V, which can be used to charge USB electronic devices. However, the battery discharging time becomes faster as a result of the consequences of escalating the voltage.

Another factor that affects the value of the boost converter output voltage is the amount of load connected to the device. The results of the load charging test show that the greater the load connected, the higher the output current will be. The design of the boost converter circuit can adjust the current supply according to the load consumption.

The results of overall tool testing show that the energy harvester system that has been designed is capable of producing enough electricity to charge electronic devices and this research while improving the weakness found in

previous studies. The module boost converter is widely available at the market, however this module can provide a maximum current supply of 250 mA and our design can provide a supply up to 1,000 mA evidenced by the tablet that can be charged. The weakness of previous research that was not prepare about concept of energy harvesting due to difficulties of harvest the heat energy directly from the exhaust due to exhaust gas was fluctuating. Therefore, it is necessary to have storage media to accommodate energy resulted of TEG. After energy accumulated, the harvesting of energy was needed. This is concept energy harvesting providing solutions for fluctuating energy sources and efficiency of low transducer with efficiency of TEG < 10% [9, 17-20].

4. Conclusion

This study succeeded in designing an energy harvesting system by using two thermoelectric generator module type TE-MOD-10W4V-40, which are arranged in series and mounted on a motorcycle exhaust. The design of the device includes the construction of the heat exchanger, the boost converter circuit, and the electronics unit. Based on the research that has been done, the results show the maximum electrical voltage that was successfully generated in the no-load condition is 4.2V with a temperature difference of 57 °C. The design of the device can charge electronic devices such as speakers, smartphones, and tablets with an output voltage of 5.2V. The time is taken from the start of the motorcycle engine to reach a constant voltage of is 3 minutes. Improvements in the efficiency must be achieved to make the TEG modules profitable for use in the motorcycle. The efficiency of the TEG is mainly a function of the thermoelectric materials used, but also depends on a good design which minimize the thermal resistance from the inner wall of the exhaust pipe to the hot surface of the module, and allows for operating in a greater range of temperatures.

References

- [1] Prianjani, D., et al. "Sustainable supply chain planning for swap battery system: Case study electric motorcycle applications in Indonesia". in IOP Conference Series: Materials Science and Engineering. IOP Publishing. 2019.
- [2] Yap, Y., R. Naayagi, and W.L. Woo. "Thermoelectric energy harvesting for mobile phone charging application". in 2016 IEEE Region 10 Conference (TENCON). IEEE. 2016.
- [3] Orr, B., et al., "A review of car waste heat recovery systems utilising thermoelectric generators and heat pipes". Applied Thermal Engineering, **101**: p. 490-495. 2016.
- [4] Mirmanto, M., H. Tira, and A. Pabriansyah, "Effect of motorcycle exhaust pipe temperature and electrical circuit on harvested dc power from thermoelectric generators". Dinamika Teknik Mesin, **10**(1): p. 41-52. 2020.
- [5] Flipsen, S., "Alternative Power Sources for Portables & Wearables, Part 1: Power Generation & Part 2: Energy Storage. Delft University of Technology", **170**. 2005.
- [6] Nag, S., A. Dhar, and A. Gupta, "Exhaust heat recovery using thermoelectric generators: a review", in Advances in Internal Combustion Engine Research. Springer. p. 193-206. 2018,
- [7] Wang, Y., C. Dai, and S. Wang, "Theoretical analysis of a thermoelectric generator using exhaust gas of vehicles as heat source". Applied Energy, **112**: p. 1171-1180. 2013.
- [8] Schlichting, A.D., S.R. Anton, and D.J. Inman. "Motorcycle waste heat energy harvesting. in Industrial and Commercial Applications of Smart Structures Technologies 2008". International Society for Optics and Photonics. 2008.
- [9] Suryawanshi, S., et al., "Use of exhaust heat energy of two wheelers to generate power by seebeck effect". 2017.
- [10] Howard, L., D. Grbovic, and A. Pollman. "Modeling and Simulation Approach to Inform TEG Waste Heat Harvesting Prototype for Fossil Fuel Exhaust. in Proceedings of the 3rd International Conference of Energy Harvesting, Storage, and Transfer (EHST'19)". Ottawa,, Canada-June. 2019.
- [11] Jahan, S., et al. "Development of Smart Cooking Stove: Harvesting Energy from the Heat, Gas Leakage Detection and IoT Based Notification System". in 2019 International Conference on Robotics, Electrical and Signal Processing Techniques (ICREST). IEEE. 2019.
- [12] Tang, Z., et al., "A research on thermoelectric generator's electrical performance under temperature mismatch conditions for automotive waste heat recovery system". Case Studies in Thermal Engineering, **5**: p. 143-150. 2015.
- [13] Guilar, N.J., R. Amirtharajah, and P.J. Hurst, "A full-wave rectifier with integrated peak selection for multiple electrode piezoelectric energy harvesters". IEEE Journal of Solid-State Circuits, **44**(1): p. 240-246. 2008.
- [14] Peirs, J., D. Reynaerts, and F. Verplaetsen, "A microturbine for electric power generation". Sensors and Actuators A: Physical, **113**(1): p. 86-93. 2004.
- [15] Hsu, C.-T., et al., "An effective Seebeck coefficient obtained by experimental results of a thermoelectric generator module". Applied energy, **88**(12): p. 5173-5179. 2011.
- [16] Rao, G.S., S. Raghu, and N. Rajasekaran, "Design of feedback controller for boost converter using optimization technique. parameters", **11**: p. 12. 2013.
- [17] Anggara, F., Anugrah, R. A., & Pranoto, H. "Thermal Energy Storage Using Horizontal Shell-Tube Heat Exchanger: Numerical Investigation on Temperature Variation of HTF". International Journal of Renewable Energy Research (IJRER), **9**(4), 2112-2117. 2019.
- [18] Ishiyama, T. "Output Characteristics of Energy Harvesting Using Multiple Energy Sources". In 2019 8th International Conference on Renewable Energy Research and Applications (ICRERA) (pp. 224-228). IEEE. 2019, November.

- [19] Sandu V, Mazilu A. "Diesel Engine Waste Heat Recovery Potential versus Driving Cycles". In 2019 8th International Conference on Renewable Energy Research and Applications (ICRERA). (pp. 331-336). IEEE. 2019 Nov.
- [20] Balaji C, Dash SS, Hari N, Babu PC. A four port non-isolated multi input single output DC-DC converter fed induction motor. In 2017 IEEE 6th International Conference on Renewable Energy Research and Applications (ICRERA) 2017 Nov 5 (pp. 631-637). IEEE. 2017.

Design of Energy Harvesters on Motorcycle Exhaust using Thermoelectric Generator for Power Supply Electronic Device

ORIGINALITY REPORT

20%

SIMILARITY INDEX

15%

INTERNET SOURCES

7%

PUBLICATIONS

15%

STUDENT PAPERS

PRIMARY SOURCES

1

mail.ijrer.org

Internet Source

9%

2

Submitted to Pasundan University

Student Paper

2%

3

Submitted to Universitas Nasional

Student Paper

1%

4

Schlichting, Alexander D., Steven R. Anton, Daniel J. Inman, Benjamin K. Henderson, and M. Brett McMickell. "", Industrial and Commercial Applications of Smart Structures Technologies 2008, 2008.

Publication

1%

5

Submitted to Rochester Institute of Technology

Student Paper

1%

6

Tahsin Atalay, Yavuz Köysal, Ali Ekber Özdemir, Engin Özbaş. "Evaluation of energy efficiency of thermoelectric generator with two-phase thermo-syphon heat pipes and nano-

1%

particle fluids", International Journal of Precision Engineering and Manufacturing-Green Technology, 2018

Publication

7

A. Khaligh. "", IEEE Transactions on Vehicular Technology, 7/2007

Publication

<1%

8

www.freepatentsonline.com

Internet Source

<1%

9

V. T. Troshchenko. "Method of investigating the regularities of unstable crack development in cyclic loading with the application of acoustic emission", Strength of Materials, 12/1985

Publication

<1%

10

Djafar, Zuryati, Nandy Putra, and Raldi A. Koestoer. "The Utilization of Heat Pipe on Cold Surface of Thermoelectric with Low-Temperature Waste Heat", Applied Mechanics and Materials, 2013.

Publication

<1%

11

Submitted to Coventry University

Student Paper

<1%

12

Submitted to Colorado Technical University Online

Student Paper

<1%

13

Kiflemariam, Robel, and Cheng-Xian Lin.

"Numerical simulation of integrated liquid cooling and thermoelectric generation for self-cooling of electronic devices", International Journal of Thermal Sciences, 2015.

Publication

<1%

14

Weng, Chien-Chou, and Mei-Jiau Huang. "A simulation study of automotive waste heat recovery using a thermoelectric power generator", International Journal of Thermal Sciences, 2013.

Publication

<1%

15

Song Lv, Wei He, Qingyang Jiang, Zhongting Hu, Xianghua Liu, Hongbing Chen, Minghou Liu. "Study of different heat exchange technologies influence on the performance of thermoelectric generators", Energy Conversion and Management, 2018

Publication

<1%

16

www.abc.net.au

Internet Source

<1%

17

Barma, M.C., M. Riaz, R. Saidur, and B.D. Long. "Estimation of thermoelectric power generation by recovering waste heat from Biomass fired thermal oil heater", Energy Conversion and Management, 2015.

Publication

<1%

18

www.ijitee.org

Internet Source

<1%

19

wims2.org

Internet Source

<1%

20

N. Putra. "Design, manufacturing and testing of a portable vaccine carrier box employing thermoelectric module and heat pipe", Journal of Medical Engineering & Technology, 2009

Publication

<1%

21

www.tandfonline.com

Internet Source

<1%

22

publications.lib.chalmers.se

Internet Source

<1%

23

www.ijrer-net.ijrer.org

Internet Source

<1%

24

COMPEL: The International Journal for Computation and Mathematics in Electrical and Electronic Engineering, Volume 33, Issue 5 (2014-09-16)

Publication

<1%

Exclude quotes On

Exclude matches Off

Exclude bibliography On